

**DRAFT COPY**

DO NOT SCALE. IF IN DOUBT ASK!

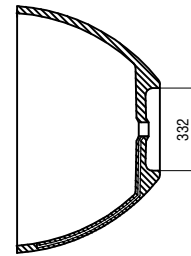

**SECTION B-B**

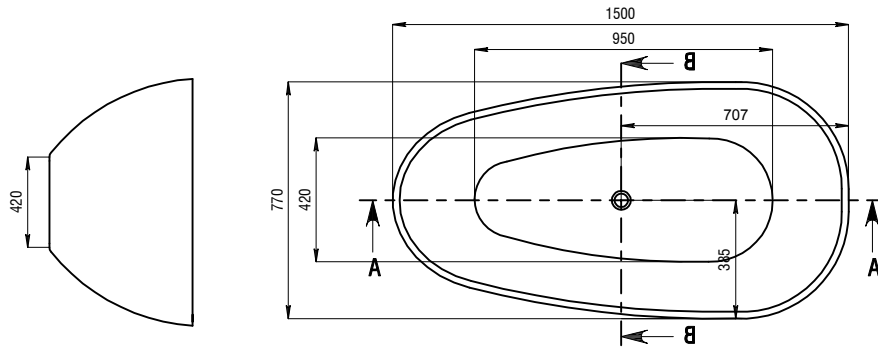
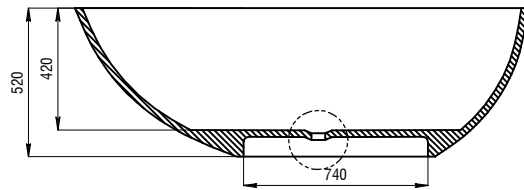
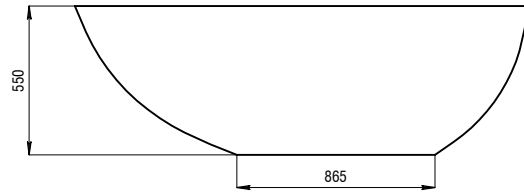
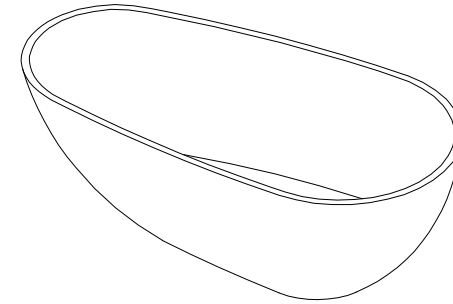

**SECTION A-A**

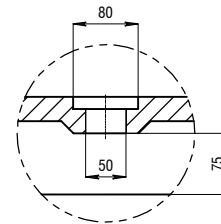

**DETAIL D  
SCALE 1:3**

<b>COLOUR</b>
<b>QTY</b>
<b>APPROVED BY:</b>
NAME & SIGNATURE
<b>DATE APPROVED:</b>

- NOTES  
 1. ALL INTERNAL CORNERS TO BE R5 UNLESS OTHERWISE STATED.  
 2. AS ALL KASKADE PRODUCTS ARE HAND FINISHED A 2-5mm TOLERANCE IS ALLOWED.

COPYRIGHT © APPLIES DUPLICATION OF THIS DRAWING OR ANY SPECIFIC DESIGN FEATURES IS NOT PERMITTED WITHOUT WRITTEN AUTHORITY. "COMMERCIAL CONFIDENTIALITY" IS ASSUMED AND REQUIRED.

UNLESS OTHERWISE STATED ALL DIMENSIONS IN MILLIMETERS	MATERIAL:	KASKADE STONE	DRAWING NUMBER	Viva-RS3-1500	SCALE 1:1	A4
	FINISH:	REFER TO ORDER			SHEET 1 OF 1	REV. 1
DRAWING LEGEND	N.W	164.5 kg	Product Size	1500X770X520	 KASKADE STONE <a href="http://www.kaskadebaths.de">www.kaskadebaths.de</a>	
	G.W	kg	Package size			
LINEAR / ANGULAR TOLERANCES	DRAWN	KASKADE	DATE	02/03/15		
No Decimals 1 Decimal 2 Decimals	CHK'D		DATE			
±5			±3°			

REV	DESCRIPTION	DWG	DATE	CHK'D	DATE
1	RELEASE DATE.	KASKADE	02/03/15		